

Thank you for purchasing the **OSLO BED**. Before you begin to assemble your new piece of furniture, please check to ensure that all hardware and parts have been supplied. This page lists all contents included in the carton(s).

Follow instructions closely as deviation from them may present a possible safety risk and may void your warranty.

It is recommended that assembly is done on a soft surface such as carpet to avoid any damage.

If you experience any problems with your new purchase please phone Freedom Customer Service (FCS) on 1300 135 588. Customers outside Australia should contact their closest Freedom store.

Care Information

High Gloss

Periodically check and re-tighten any fasteners. Avoid direct sunlight. Dust the surface weekly using a soft cloth. Please note that high gloss surfaces are delicate and with everyday use you must expect some visual signs of wear on the surface of the product. It is important to remove moist substances immediately. Remove stains with a soft cloth to avoid marks on the surface.









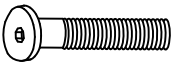
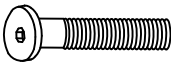

Timber

Periodically check and re-tighten any fasteners. Dust weekly using a soft, clean cloth. Do not use harsh abrasives, chemicals or polishes containing silicone. Avoid direct sunlight as this will cause the timber to change colour. It is important to remove moist substances immediately. Use coasters, placemats and table runners to assist in prolonging the life of your product.

Metal

Periodically check and re-tighten any fasteners. Avoid direct sunlight. Dust the surface weekly using a soft cloth. Please note that metal surfaces with everyday use, you must expect some visual signs of wear on the surface of the product. It is important to remove moist substances immediately. Remove stains with a soft cloth to avoid marks on the surface.

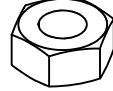
Hardware (Supplied)

					
A x12 M6*35	B x16 M8*25	C x12 M6/M16	D x12 M6	E x1 4mm	F x4 160*160
					
G x8 M8*90	H x8 30*9	I x8 M8	J x1 5mm	K x8	L x1

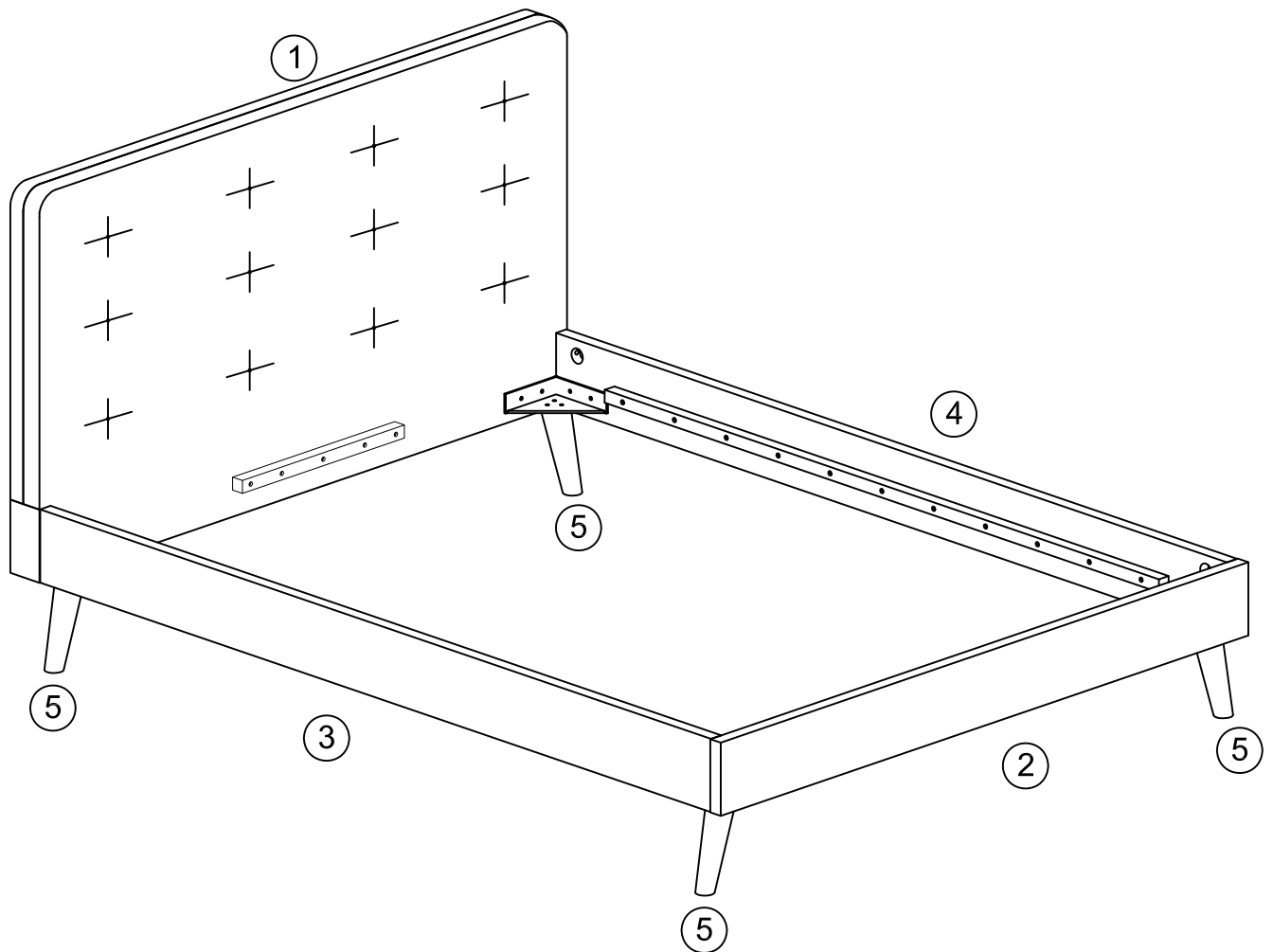



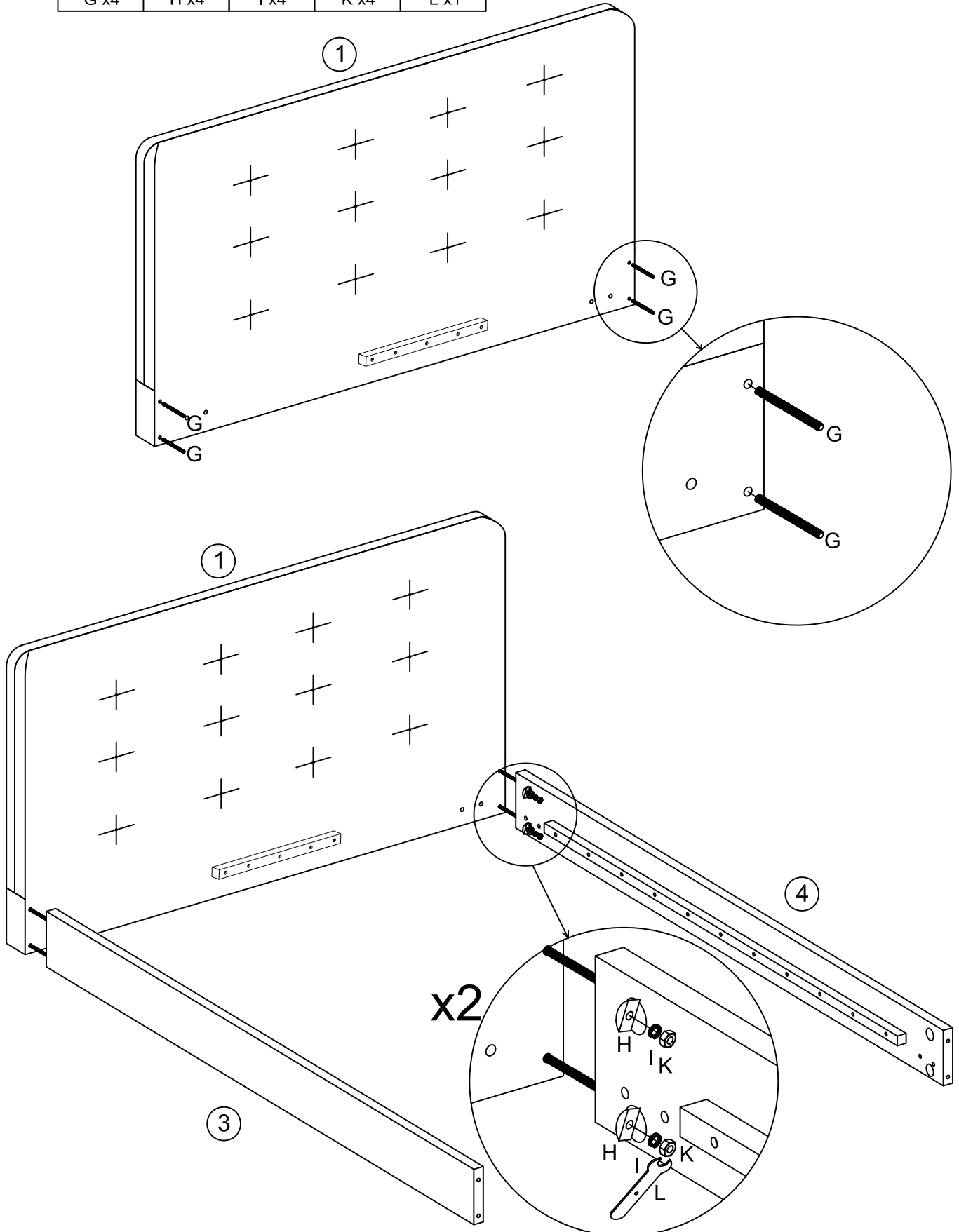
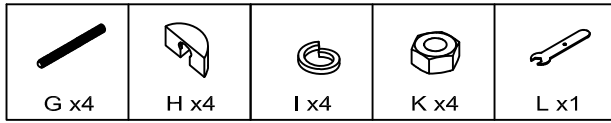

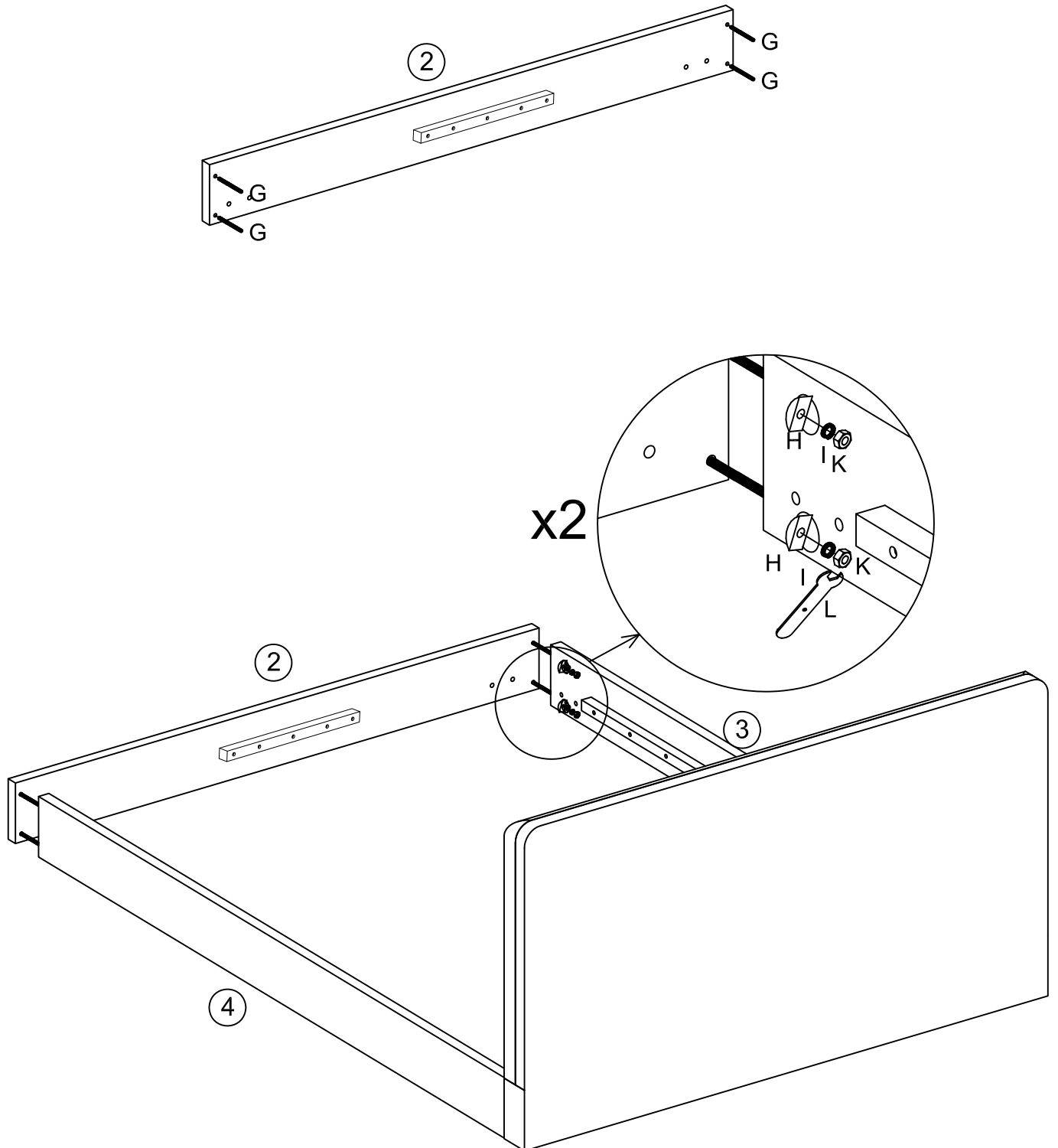
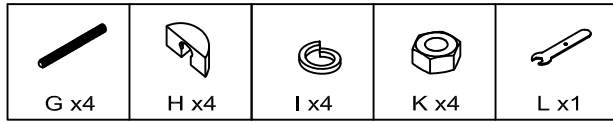

Step 1.



Step 2.



Step 3.

						
A x12	B x16	C x12	D x12	E x1	F x4	J x1

